

PY PLAST

Ahmet Polat Yapı Markasıdır

www.ahmetpolat.com.tr





HAKKIMIZDA *about our business*

46 yılı aşkın tecrübesiyle inşaat ve inşaat malzemeleri alanında faaliyet gösteren şirketimiz, üretimini gerçekleştirdiği ürünleri, yurtiçi ve yurtdışında bir çok noktaya ulaştırmaktadır.

"Kaliteli hizmet" anlayışıyla sürdürdüğümüz faaliyetlerimizde hedefimiz "en iyiyi" başarmaktır.

Faaliyet gösterdiğimiz alanlarda edindiğimiz tecrübeyi 2009 yılında "Ahmet Polat Yapı Elamanları" çatısı altında birleştirdik. Bayilerimize, yüksek kalite yapı ve inşaat malzemeleri üretimi ve satışıyla hizmet vermekteyiz.

"Py Plast" markası altında yapı market pazarına kazandırdığımız seramik ve ısı yalıtım aksesuarlarını Erzurum'da bulunan tesislerimizde üretmekteyiz. Üretim bandımızdaki ürünlerden bazılarını yalıtım dübelleri, derz aparatları, elektrik kasaları, sabitleme takozu, seviye derz artısı, fayans derz artısı, kılçık (yere tespit kroşesi), çelik çivili plastik dübel, yandan çivili plastik dübel, metal sıkıştırma pensesi, plastik sıkıştırma pensesi, klozet kapakları, duş kanalları ve yer süzgeçleri olarak sıralayabiliriz.

Ahmet Polat Yapı Tic. Ltd. Şti. müşterilerini memnun etmek için her zaman en kaliteli tedarikçiler, en itibarlı çözüm ortakları ve en donanımlı personel ile çalışarak kendisini sürekli geliştirmekte; müşteri ihtiyaçlarının gerektirdiği sürdürülebilir dönüşüm için çalışanlarını, çözüm ortaklarını ve tedarikçilerini sürekli yenilikçi teknolojilerle desteklemektedir.

Ana felsefemiz, "kaliteli hizmet" olup bundan asla taviz vermeyeceğiz. Hedefimiz, ulusal ve evrensel ölçekte ülkemize değer katan, işini mükemmel yapan bir marka oluşturmaktır.

Our company, which has operated in the field of construction and construction materials with more than 46 years of experience, delivers its products to many parts of the Turkey and abroad.

Our goal in our activities, which we carry out with the concept of "quality service", is to achieve the "best".

We combined our experience in the fields we operate under the roof of "Ahmet Polat Construction Elements" in 2009. In our dealers, we provide service with the production and sale of high-quality building and construction materials.

We produce ceramics and thermal insulation equipment that we brought to the DIY market under the brand of "Py Plast" in our facilities in Erzurum. We can list some of the products in our production line as insulation dowels, joint apparatus, electrical boxes, fixing wooden wedges, level joint plus, tile joint plus, fishbone ground fastening hook, plastic dowel with steel nails, plastic dowel with side nails, metal clamping pliers, plastic clamping pliers, toilet seat cover, shower channels and floor drains.

Ahmet Polat Trade. Ltd. Co. is constantly improving itself by working with the best quality suppliers, the most reputable solution partners and the most qualified personnel in order to please its customers; It continuously supports its employees, solution partners and suppliers with innovative technologies for the sustainable transformation by customer needs.

Our main philosophy is "quality service" and we will never compromise on this. Our goal is to create a brand that contributes to our country on a national and global scale and does its job perfectly.

PY - 01

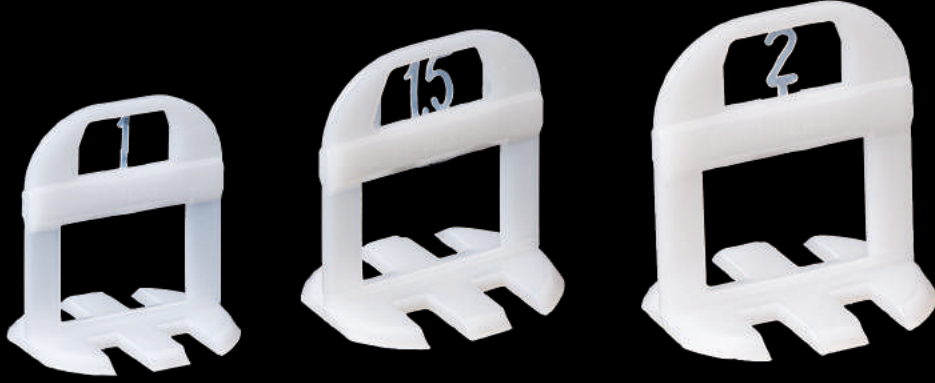

PYPLAST
Ahmet Polat Yapı Markasıdır

SEVİYE DERZ ARTISI

Levelling Spicer

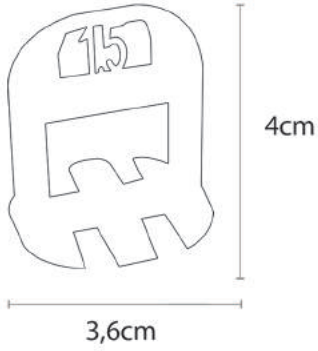

Çapı Diameter	Yükseklik Height	Ürün Kodu Code	Paket Adeti Pack Qty
Ø	1 mm	PY-SA-001-01	200
Ø	1,5 mm	PY-SA-001-02	200
Ø	2 mm	PY-SA-001-03	200

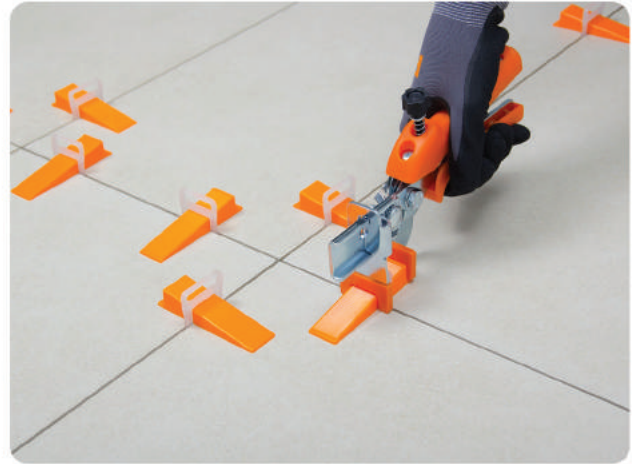

PY - 02



PYPLAST
Ahmet Polat Yapı Markasıdır

SABİTLEME TAKOZU
Fixing Wedge

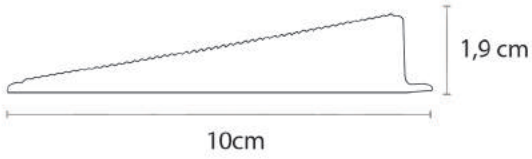

Çapı Diameter	Yükseklik Height	Ürün Kodu Code	Paket Adeti Pack Qty
Ø	1,9 mm	PY-ST-002-01	100

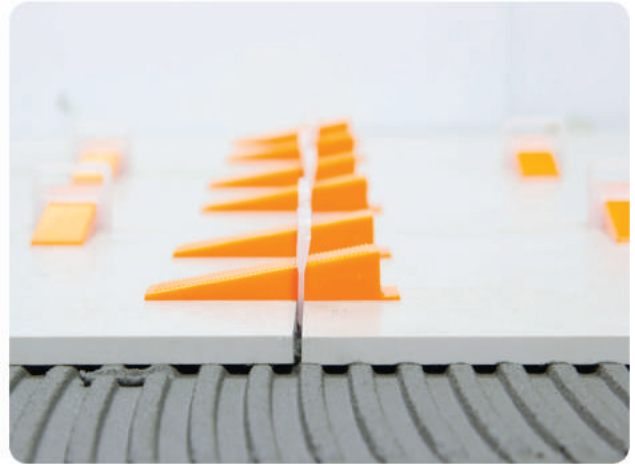

PY - 03



PYPLAST
Ahmet Polat Yapı Markasıdır

KILÇIK(YERE TESPİT KROŞESİ)
Ground Fixing Anchor

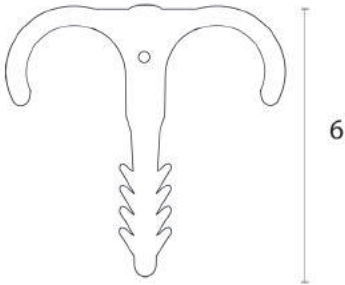

Çapı Diameter	Kalınlık Thickness	Yükseklik Height	Ürün Kodu Code	Paket Adeti Pack Qty
Ø	5mm	60 mm	PY-BK-003-01	250
Ø	5mm	60 mm	PY-SK-003-02	250



PY - 04



PYPLAST
Ahmet Polat Yapı Markasıdır

YERDEN ISITMA BORU TUTUCU U KLİPS

Underfloor Heating Pipe Retainer U Clips

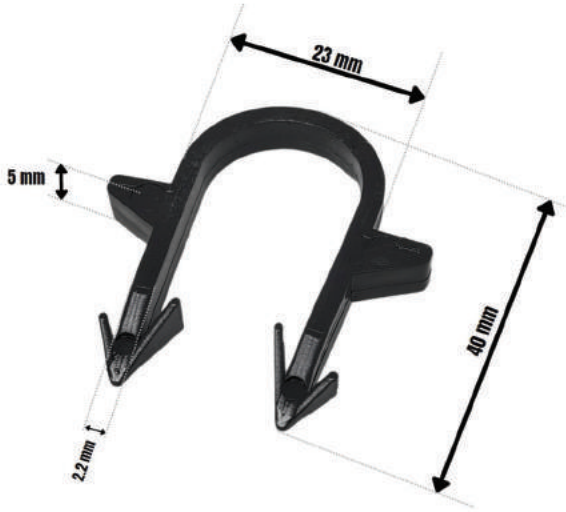

Avantajları

- Boru ve hortumların döndürülerek çıkartılmasını önleyen bir araçtır ve bu sayede boru ve hortumların güvenli bir şekilde sabitlenmesini sağlar.

- Kullanımı kolaydır, ucundaki sivri kısımlar ile strofora hemen saplanır ve geri çıkmaz. Eliniz ile kolayca bastırarak boruyu sabitleyebilirsiniz.

Advantages

- It is a tool that prevents pipes and hoses from being removed by rotating and thus ensures that pipes and hoses are securely fixed.

- It is easy to use, it is immediately stuck into the strophor with the pointed parts at the end and does not come back out. You can fix the pipe by pressing it easily with your hand.

Kullanım Alanları

- Yerden ısıtma tesisatlarında strofor veya yalıtım levhasına borunun sabitlenmesi için kullanılmaktadır.

- Pex boruların köpüklü yerden ısıtma levhasına montajı esnasında boruların mantarlardan veya klipsli lamalardan kurtulması olasıdır. Bu gibi durumlarda u klips boru tutucu işinizi kolaylaştırarak boruların kalkmasını engeller.

Usage Areas

- It is used for fixing the pipe to the strophor or insulation board in underfloor heating installations.

- During the installation of pex pipes on the foamed underfloor heating board, it is possible that the pipes will get rid of corks or clip-on lamas. In such cases, the u clip pipe holder makes your job easier and prevents the pipes from lifting.

Paket Adeti
Pack Qty
500

PY - 05



PYPLAST
Ahmet Polat Yapı Markasıdır

YANDAN ÇİVİLİ PLASTİK DÜBEL

Side Nail Plastic Dowel

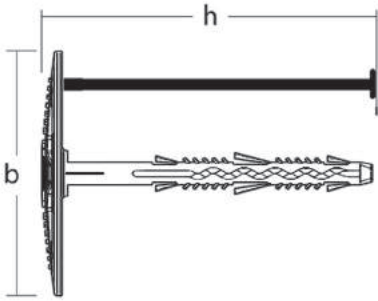

Çapı Diameter	Yükseklik Height	Ürün Kodu Code	Paket Adeti Pack Qty
Ø	10cm	PY-PD-005-01	500
Ø	12cm	PY-PD-005-02	500
Ø	14cm	PY-PD-005-03	500

Uygulama Alanları Scope of Application



PY - 06



PYPLAST
Ahmet Polat Yapı Markasıdır

ÇELİK ÇİVİLİ PLASTİK DÜBEL

Side Nail Plastic Dowel

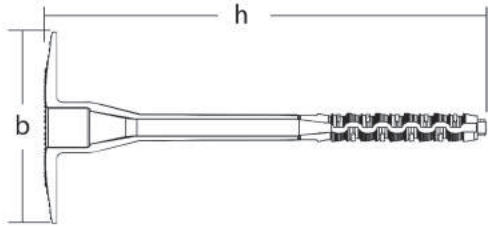

Çapı Diameter	Yükseklik Height	Ürün Kodu Code	Paket Adeti Pack Qty
Ø	11.5cm	PY-ÇD-006-01	500
Ø	13.5cm	PY-ÇD-006-02	500
Ø	15.5cm	PY-PD-006-03	500

Uygulama Alanları Scope of Application

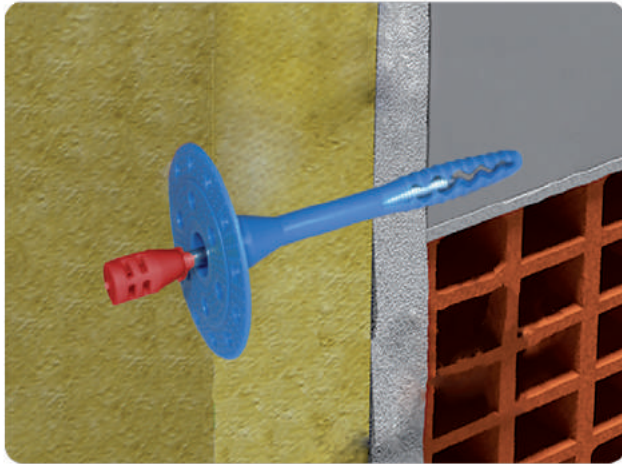

PY - 07



PY PLAST
Ahmet Polat Yapı Markasıdır

METAL SIKIŞTIRMA PENSESİ

Metal Crimping Pliers

PLASTİK SIKIŞTIRMA PENSESİ

Plastic Compression Pliers

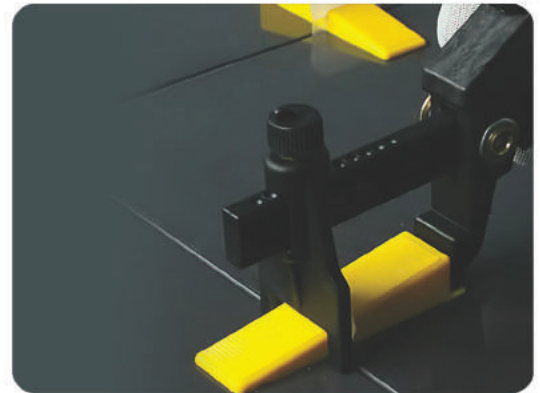

PY - 08

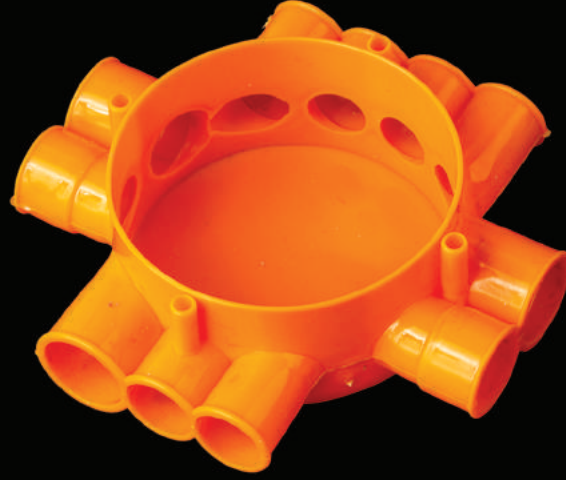

PYPLAST
Ahmet Polat Yapı Markasıdır

ELEKTRİK BUAT & KASASI

Electric Case Button

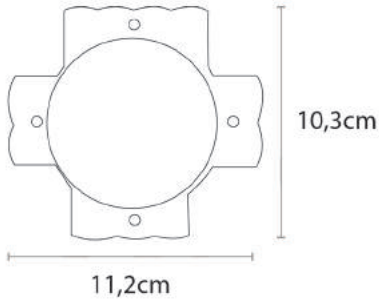

Çapı Diameter	Yükseklik Height	Ürün Kodu Code	Paket Adeti Pack Qty
Ø	2 mm	PY-BA-008-01	100

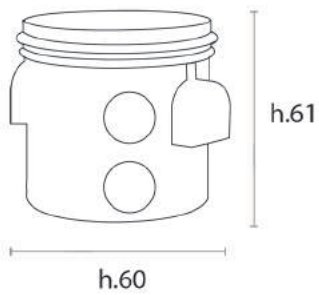

Çapı Diameter	Yükseklik Height	Ürün Kodu Code	Paket Adeti Pack Qty
Ø	2 mm	PY-GK-103-01	100

KLOZET KAPAKLARI

PY PLAST

PY PLAST
Ahmet Polat Yapı Markasıdır

PY - 09

KLOZET KAPAKLARI

Side Channel

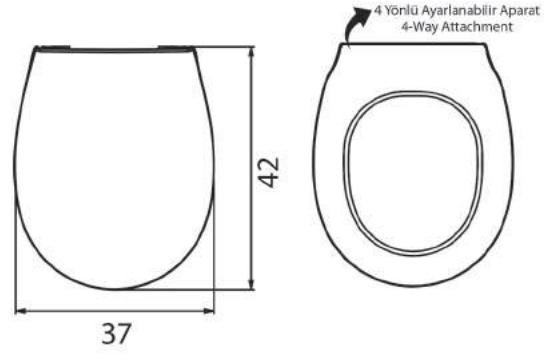

Genişlik Width	Yükseklik Height	Ürün Kodu Code	Paket Adeti Pack Qty
37cm	42cm	PY-KKO-009-01	1



KLOZET KAPAKLARI

PY PLAST

PY PLAST
Ahmet Polat Yapı Markasıdır

PY - 10

KLOZET KAPAKLARI

Side Channel

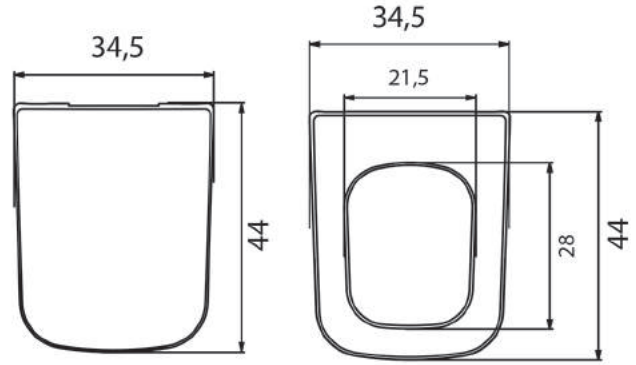

Geniřlik Width	Yükseklik Height	Ürün Kodu Code	Paket Adeti Pack Qty
34,5cm	44cm	PY-KKO-010-01	1









PY - 11



PYPLAST
Ahmet Polat Yapı Markasıdır

DUŞ KANALLARI

Side Channel

 Lenght / Uzunluk a	 Width / Genişlik b	 Height / Yükseklik h	 Code / Ürün Kodu	 Outlet / Çıkış Çapı	 Pack Qty / Paket Adeti
20 cm	6 cm	4,5 cm	PY-DK-011-01	Q50	36
33 cm	6 cm	4,5 cm	PY-DK-011-02	Q50	20
40 cm	6 cm	4,5 cm	PY-DK-011-03	Q50	18
50 cm	6 cm	4,5 cm	PY-DK-011-04	Q50	12
60 cm	6 cm	4,5 cm	PY-DK-011-05	Q50	12

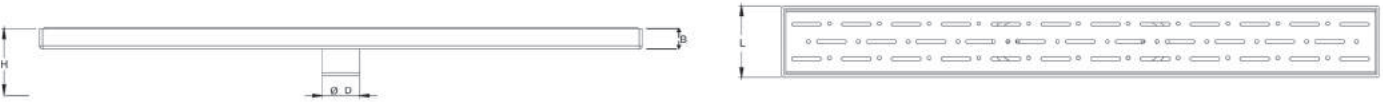

L	H	ØD	B
6 cm	4,5 cm	50 cm	1,7 cm

Izgara Desen Seçenekleri

Grill Design Options

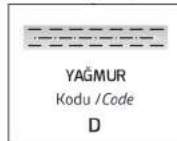

Izgara Renk Seçenekleri

Grill Color Options



Lütfen desen ve renk seçenekleri için bilgi alın.
Please inquire for pattern and color options.



PYPLAST
Ahmet Polat Yapı Markasıdır

DUŞ KANALLARI

Side Channel

Kullanım Alanları

- Yalıtımlı veya yalıtımsız duşlarda ekonomik çözüm olarak sunulur. İstenmesi halinde uygulama sırasında ikiz gider özelliği eklenebilir. Duvar gibi uygulamaları içinde kullanılabilir.
- Banyo duşları
- Sauna ve spalar
- Hastane ve otel duşları
- Fitness center soumma odaları ve duşları

Areas of Use

- It is offered as an economical solution in insulated or non-insulated showers. If desired, the twin drain feature can be added during installation. It can be used in wall-mounted applications.
- Bathroom showers
- Saunas and spas
- Hospital and hotel showers
- Fitness center locker rooms and showers

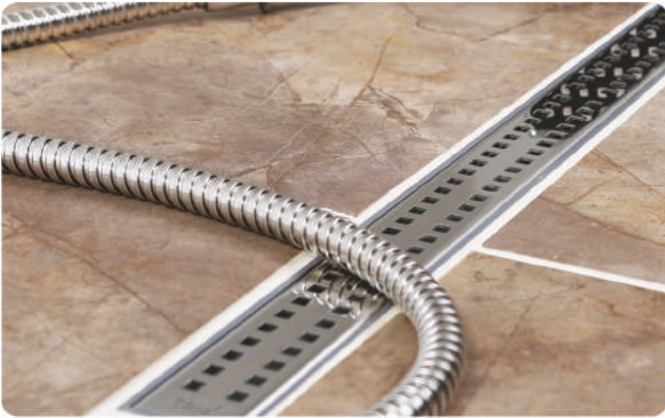

YAĞMUR



YILDIZ



DAMLA



Lütfen desen ve renk seçenekleri için bilgi alın.
Please inquire for pattern and color options.

PY - 12

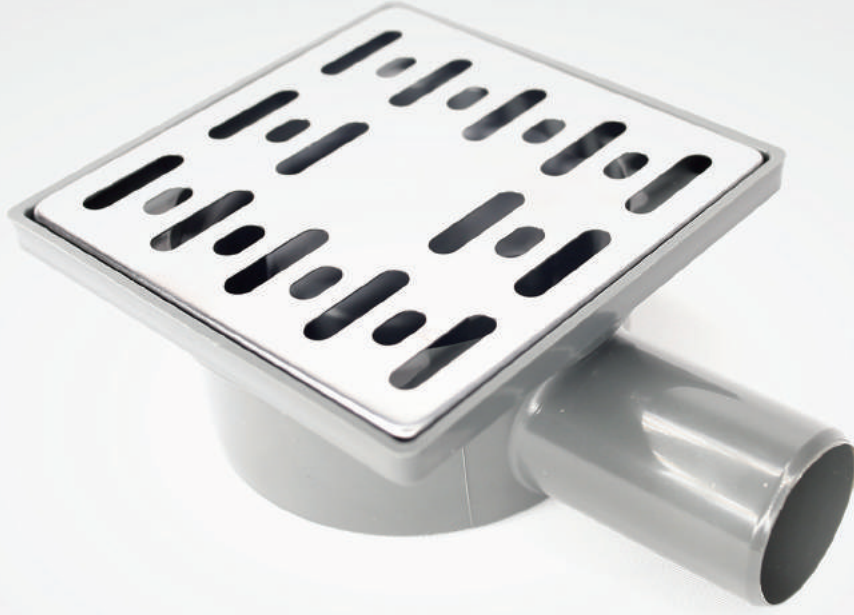

PYPLAST
Ahmet Polat Yapı Markasıdır

10x10 Plastik Çerçevesi Klasik Seri Yer Süzgeçleri
10x10 Plastic Frame, Classical Series Floor Drainer

Çıkış Çapı Outlet Diameter	Yükseklik Height	Ürün Kodu Code	Çıkış Yönü Outlet Direction	Paket Adeti Pack Qty
Ø32	5 cm	PY-DK-012-01	Side / Yan	140

Izgara Desen Seçenekleri

Grill Design Options

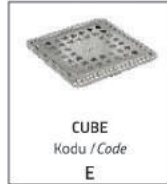

Izgara Renk Seçenekleri

Grill Color Options



Lütfen desen ve renk seçenekleri için bilgi alın.
Please inquire for pattern and color options.

PY - 13



PYPLAST
Ahmet Polat Yapı Markasıdır

10x10 Plastik Çerçevesi Klasik Seri Yer Süzgeçleri
10x10 Plastic Frame, Classical Series Floor Drainer

Çıkış Çapı Outlet Diameter	Yükseklik Height	Ürün Kodu Code	Çıkış Yönü Outlet Direction	Paket Adeti Pack Qty
Ø50	7cm	PY-DK-013-01	Side / Yan	140

Izgara Desen Seçenekleri

Grill Design Options



Izgara Renk Seçenekleri

Grill Color Options

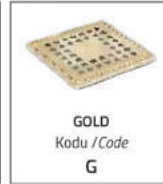

Lütfen desen ve renk seçenekleri için bilgi alınız.
Please inquire for pattern and color options.

PY - 14



PYPLAST
Ahmet Polat Yapı Markasıdır

360° DÖNERLİ YANDAN ÇIKIŞLI KLASİK SERİ DUŞ KANALLARI 360° Rotating Side Outlet Classical Series Shower Chan

Lenght / Uzunluk a	Width / Genişlik b	Height / Yükseklik h	Code / Ürün Kodu	Outlet / Çıkış Çapı	Pack Qtty / Paket Adeti
33 cm	6 cm	4,5 cm	PY-DK-014-01	Q50	20
40 cm	6 cm	4,5 cm	PY-DK-014-02	Q50	20
50 cm	6 cm	4,5 cm	PY-DK-014-03	Q50	20
60 cm	6 cm	4,5 cm	PY-DK-014-04	Q50	20



L	H	ØD	B
6 cm	4,5 cm	50 cm	1,7 cm

Izgara Desen Seçenekleri

Grill Design Options



YAGMUR
Kodu / Code
D

Izgara Renk Seçenekleri

Grill Color Options



YAGMUR
Kodu / Code
S

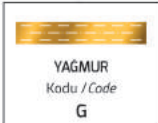

YAGMUR
Kodu / Code
G

Avantajları

- Plastik yalıtımlı eteği sayesinde son seramik sırası ile süzgeç arasında oluşan su kaçak bölgesinde su yalıtımı uygulamasına ve düzgün seramik döşemesine olanak sağlar.
- 304 kalite paslanmaz çelik ızgaralıdır.
- 360o dönebilen lamine contalı alt gövdesi ile her yönden gelen tesisat borusuna kolayca bağlanabilir.
- Duvar dibi uygulamaları için uygundur.
- Yükseklik ayarlı ayakları montajı kolaylaştırır. İstenilen yükseklikte eğim betonu dökülmesine olanak tanır.

Kullanım Alanları

- Yalıtımlı veya yalıtımsız duşlarda ekonomik çözüm olarak sunulur. İstenmesi halinde uygulama sırasında ikiz gider özelliği eklenebilir. Duvar gibi uygulamaları içinde kullanılabilir.
- Banyo duşları
- Sauna ve spalar
- Hastane ve otel duşları
- Fitness center saunma odaları ve duşları

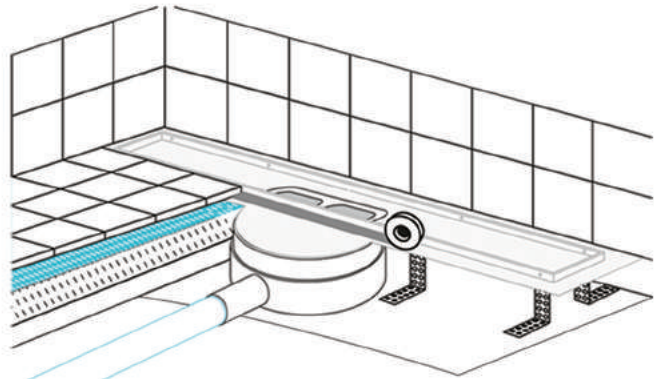

Lütfen desen ve renk seçenekleri için bilgi alın.
Please inquire for pattern and color options.

PY - 15



PYPLAST
Ahmet Polat Yapı Markasıdır

304 Kalite Paslanmaz Çelik Üçgen Köşe Süzgeç Floor Drain, Triangular Corner Drain 304 Stainl

 Code / Ürün Kodu	 Outlet / Çıkış Çapı	 Length / Uzunluk a	 Pack Qty / Paket Adeti
PY-DK-015-01	Q50	25 cm	20

Izgara Desen Seçenekleri

Grill Design Options

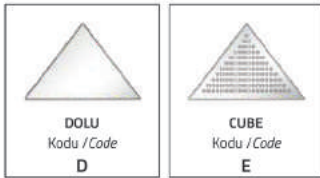

Advantages

- Thanks to its plastic insulated skirt, it allows water-proofing in the water leakage area formed between the last row of ceramics and the strainer and enables smooth ceramic laying.
- 304 quality stainless steel grate.
- It can be easily connected to the plumbing pipe coming from all directions with its laminated gasket bottom body that can rotate 360 degrees.
- Suitable for wall-mounted applications.
- Height adjustable feet make assembly easy. It allows pouring slope concrete at desired height.

Areas of Use

- It is offered as an economical solution in insulated or non-insulated showers. If desired, the twin drain feature can be added during installation. It can be used in wall-mounted applications.
- Bathroom showers
- Saunas and spas
- Hospital and hotel showers
- Fitness center locker rooms and showers

Izgara Renk Seçenekleri

Grill Color Options

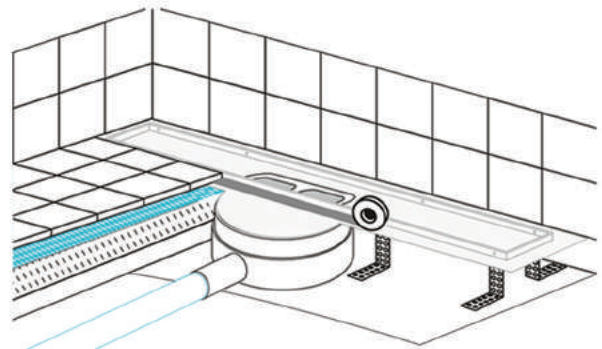
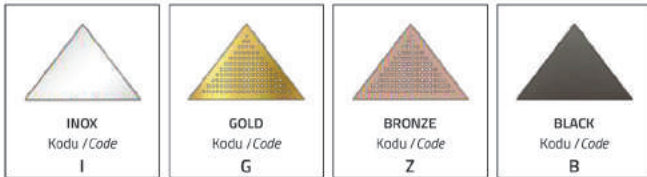

Lütfen desen ve renk seçenekleri için bilgi alınır.
Please inquire for pattern and color options.

PY - 16

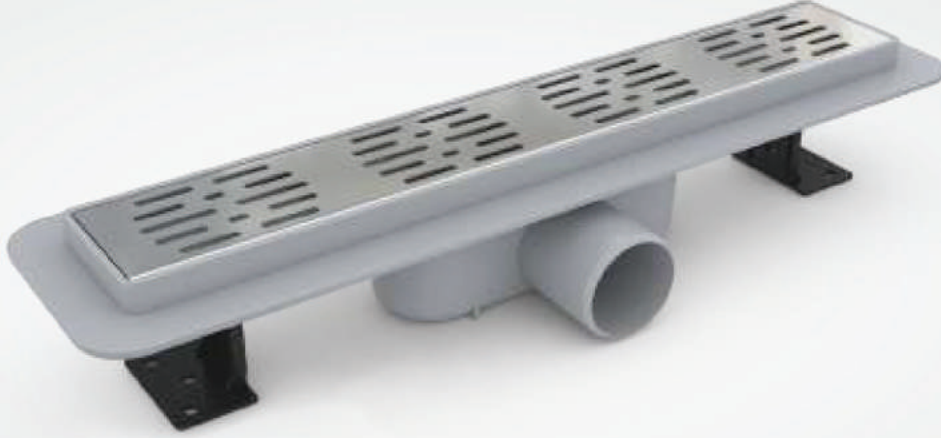

PYPLAST
Ahmet Polat Yapı Markasıdır

SABİT ÇIKIŞLI YALITIM ETEKLİ DUŞ KANALLARI

Fixed Side Outlet Shower Channels With Insulation Hem

 Length / Uzunluk a	 Width / Genişlik b	 Height / Yükseklik h	 Code / Ürün Kodu	 Outlet / Çıkış Çapı	 Pack Qty / Paket Adeti
30 cm	6 cm	7,5 cm	PY-DK-016-01	Q50	20
40 cm	6 cm	7,5 cm	PY-DK-016-02	Q50	20
50 cm	6 cm	7,5 cm	PY-DK-016-03	Q50	20
60 cm	6 cm	7,5 cm	PY-DK-016-04	Q50	20

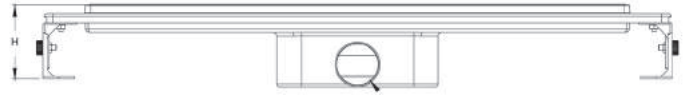
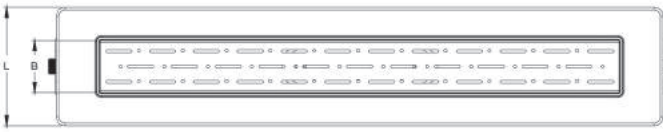

L	H	ØD	B
11 cm	7,5 cm	50 cm	6 cm

Izgara Desen Seçenekleri

Grill Design Options

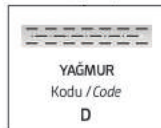

Izgara Renk Seçenekleri

Grill Color Options

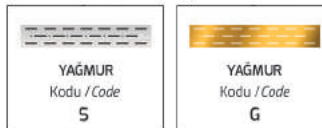

Lütfen desen ve renk seçenekleri için bilgi alın.
Please inquire for pattern and color options.

PY - 17

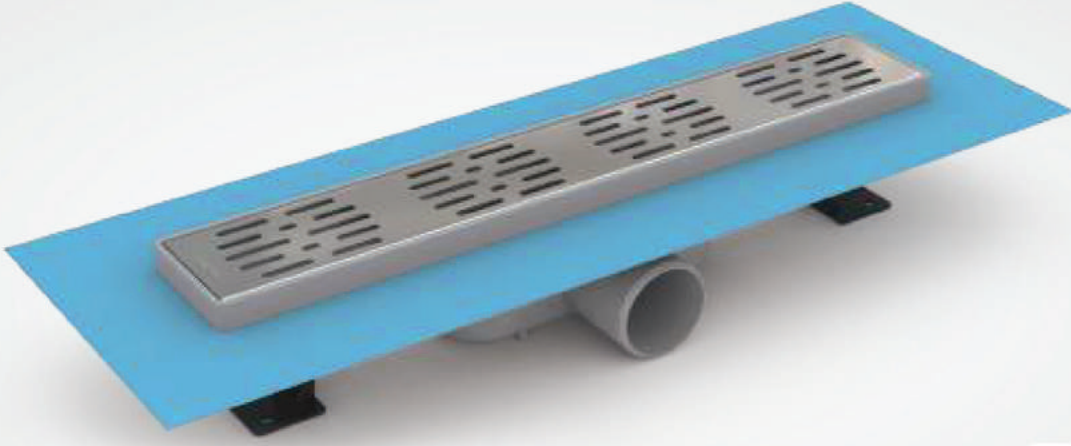

PYPLAST
Ahmet Polat Yapı Markasıdır

SABİT ÇIKIŞLI YALITIM ETEKLİ DUŞ KANALLARI (MEBRANLI)

Fixed Side Outlet Textile Membrane, Shower Channels

Lenght / Uzunluk a	Width / Genişlik b	Height / Yükseklik h	Code / Ürün Kodu	Outlet / Çıkış Çapı	Pack Qty / Paket Adeti
30 cm	6 cm	7,5 cm	PY-DK-017-01	Q50	20
40 cm	6 cm	7,5 cm	PY-DK-017-02	Q50	20
50 cm	6 cm	7,5 cm	PY-DK-017-03	Q50	20
60 cm	6 cm	7,5 cm	PY-DK-017-04	Q50	20

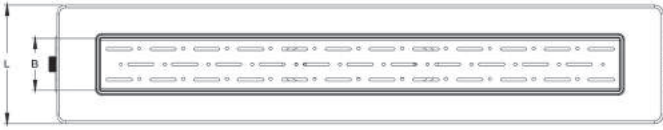

L	H	ØD	B
11 cm	7,5 cm	50 cm	6 cm

Izgara Desen Seçenekleri

Grill Design Options

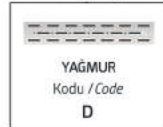

Izgara Renk Seçenekleri

Grill Color Options

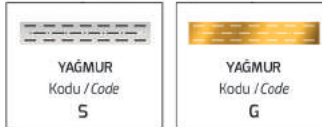

Lütfen desen ve renk seçenekleri için bilgi alınız.
Please inquire for pattern and color options.

PY - 18



PYPLAST
Ahmet Polat Yapı Markasıdır

360°DÖNERLİ YALITIM ETEKLİ YANDAN ÇIKIŞLI DUŞ KANALLARI 360° Rotating Side Outlet Shower Channels with Insulation Hem

Lenght / Uzunluk a	Width / Genişlik b	Height / Yükseklik h	Code / Ürün Kodu	Outlet / Çıkış Çapı	Pack Qty / Paket Adeti
33 cm	6 cm	7,5 cm	PY-DK-018-01	Q50	20
40 cm	6 cm	7,5 cm	PY-DK-018-02	Q50	20
50 cm	6 cm	7,5 cm	PY-DK-018-03	Q50	20
60 cm	6 cm	7,5 cm	PY-DK-018-04	Q50	20



L	H	ØD	B
11 cm	7,5 cm	50 cm	6 cm

Izgara Desen Seçenekleri

Grill Design Options



Izgara Renk Seçenekleri

Grill Color Options



Avantajları

- Plastik yalıtımlı eteği sayesinde son seramik sırası ile süzgeç arasında oluşan su kaçak bölgesinde su yalıtımı uygulamasına ve düzgün seramik döşemesine olanak sağlar.
- 304 kalite paslanmaz çelik ızgaralıdır.
- 360° dönebilen lamine contalı alt gövdesi ile her yönden gelen tesisat borusuna kolayca bağlanabilir.
- Duvar dibli uygulamaları için uygundur.
- Yükseklik ayarlı ayakları montajı kolaylaştırır. İstenilen yükseklikte eğim betonu dökülmesine olanak tanır.

Kullanım Alanları

- Yalıtımlı veya yalıtımsız duşlarda ekonomik çözüm olarak sunulur. İstenmesi halinde uygulama sırasında ikiz gider özelliği eklenebilir. Duvar gibi uygulamaları içinde kullanılabilir.
- Banyo duşları
- Sauna ve spalar
- Hastane ve otel duşları
- Fitness center sounma odaları ve duşları

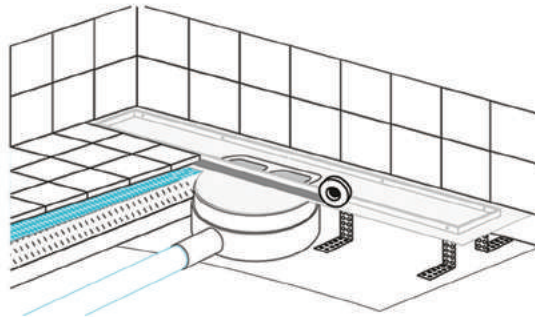

Lütfen desen ve renk seçenekleri için bilgi alın.
Please inquire for pattern and color options.



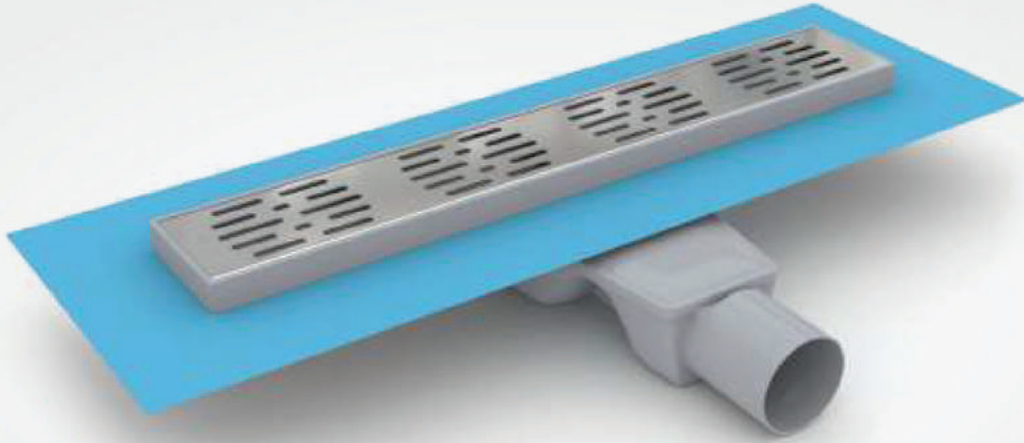



PY - 19



PYPLAST
Ahmet Polat Yapı Markasıdır

360°DÖNERLİ YALITIM ETEKLİ YANDAN ÇIKIŞLI DUŞ KANALLARI (MEBRANLI)

360° Rotating Textile Membrane Shower Channels with Insulation He

 Length / Uzunluk a	 Width / Genişlik b	 Height / Yükseklik h	 Code / Ürün Kodu	 Outlet / Çıkış Çapı	 Pack Qty / Paket Adeti
33 cm	6 cm	7,5 cm	PY-DK-019-01	Q50	20
40 cm	6 cm	7,5 cm	PY-DK-019-02	Q50	20
50 cm	6 cm	7,5 cm	PY-DK-019-03	Q50	20
60 cm	6 cm	7,5 cm	PY-DK-019-04	Q50	20



L	H	ØD	B
11 cm	7,5 cm	50 cm	6 cm

Izgara Desen Seçenekleri

Grill Design Options



Izgara Renk Seçenekleri

Grill Color Options

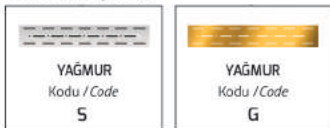

Advantages

- Thanks to its plastic insulated skirt, it allows waterproofing in the water leakage area formed between the last row of ceramics and the strainer and enables smooth ceramic laying.
- 304 quality stainless steel grate.
- It can be easily connected to the plumbing pipe coming from all directions with its laminated gasket bottom body that can rotate 360 degrees.
- Suitable for wall-mounted applications.
- Height adjustable feet make assembly easy. It allows pouring slope concrete at desired height.

Areas of Use

- It is offered as an economical solution in insulated or non-insulated showers. If desired, the twin drain feature can be added during installation. It can be used in wall-mounted applications.
- Bathroom showers
- Saunas and spas
- Hospital and hotel showers
- Fitness center locker rooms and showers

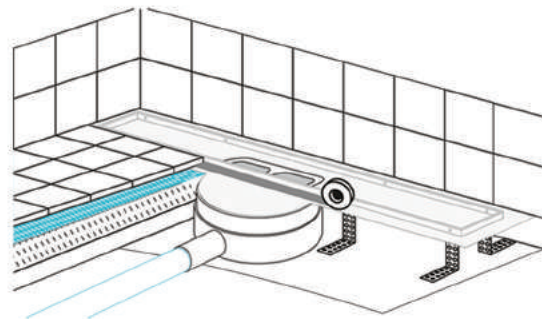

Lütfen desen ve renk seçenekleri için bilgi alın. Please inquire for pattern and color options.

PY - 20



PYPLAST
Ahmet Polat Yapı Markasıdır

FAYANS DERZ ARTISI Tile Joint Plus

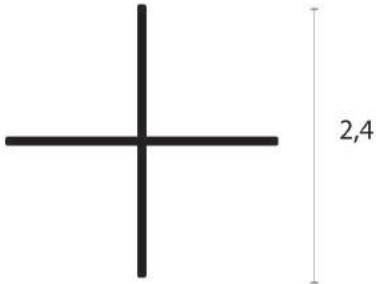

Çapı Diameter	Kalınlık Thickness	Yükseklik Height	Ürün Kodu Code	Paket Adeti Pack Qty
Ø	2mm Tutmalı	24 mm	PY-TDA-004-01	
Ø	3mm Tutmalı	24 mm	PY-TDA-004-02	
Ø	3mm Oluklu	24 mm	PY-ODA-004-03	



PY - 21

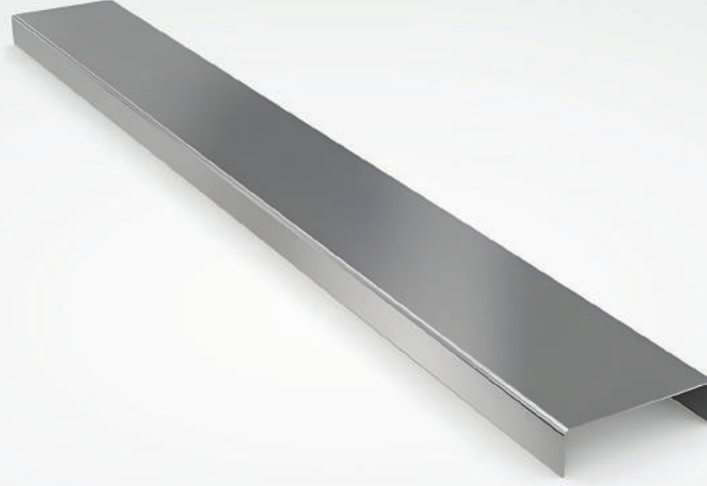

PYPLAST
Ahmet Polat Yapı Markasıdır

METAL BORDÜR

Underfloor Heating Pipe Retainer U Clips

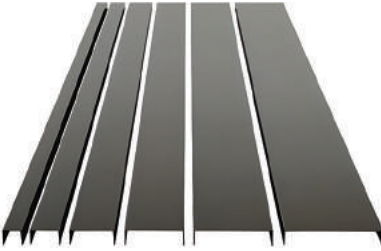
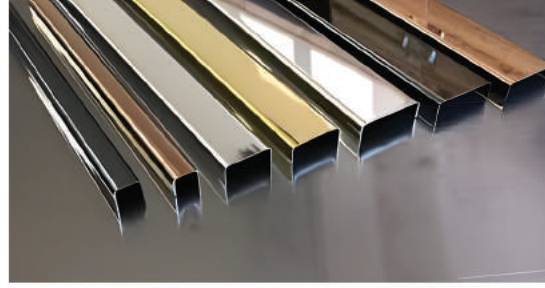

Avantajları

- Metal bordürler, banyo tasarımına estetik bir değer katar ve birçok farklı stil, metal türü ve desen seçeneği sunar, böylece banyonuzun görünümünü kişiselleştirmenize yardımcı olur.

- Metal bordürler, nemli banyo ortamına dayanıklıdır, uzun ömürlüdür ve temizliği kolaydır. Ayrıca banyo içinde farklı alanları sınırlamak ve tanımlamak için kullanılabilirler.

Advantages

- Metal borders add an aesthetic value to the bathroom design and offer many different styles, metal types and pattern options, thus helping you to personalize the appearance of your bathroom.

- Metal borders are resistant to humid bathroom environment, have a long service life and are easy to clean. They can also be used to limit and define different areas inside the bathroom.

Kullanım Alanları

- Metal bordürler, banyo tasarımına estetik bir değer katar. Duvarları veya fayansları vurgulamak için kullanılır. Ayrıca, banyo tasarımını tanımlamak ve zenginleştirmek için kullanışlıdır.

- Metal bordürler, banyo tasarımının işlevselliğine katkıda bulunur. Duş altlıkları suyun akışını yönlendirirken, banyo dolapları veya tezgahları çerçeveleyerek düzeni ve estetiği artırır. Aynı zamanda jakuzi veya küvet çevresinde işlevsel sınırlamalar oluşturur.

Usage Areas

- Metal borders add an aesthetic value to the bathroom design. It is used to highlight walls or tiles. In addition, it is useful for defining and enriching the bathroom design.

- Metal borders contribute to the functionality of the bathroom design. Shower pads direct the flow of water, while the bathroom enhances the layout and aesthetics by framing cabinets or countertops. It also creates functional limitations around the jacuzzi or bathtub.

Ölçüler / Dimensions

1 cm 1,5 cm 2 cm 3 cm 5 cm

Renk Seçenekleri / Colour options



Paket Adeti
Pack Qty

90



Lütfen desen ve renk seçenekleri için bilgi alınız.
Please inquire for pattern and color options.

ahmetpolat.com.tr

PY - 22

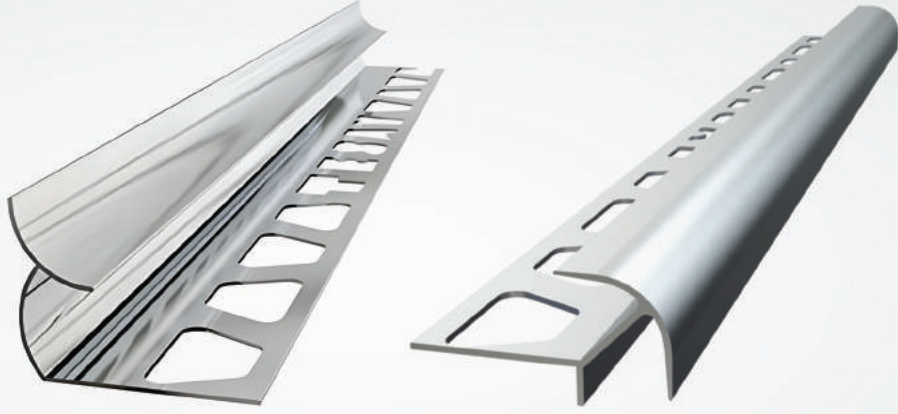

PYPLAST
Ahmet Polat Yapı Markasıdır

SERAMİK İÇ DİŞ ALÜMİNYUM KÖŞE PROFİLLERİ

Ceramic Interior Exterior Aluminum Corner Profiles

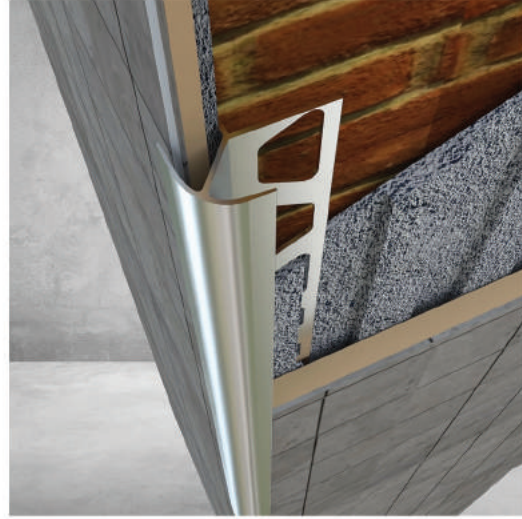

Avantajları

- Bu profiller, köşelerin darbelere, çizilmelere ve sıvı sızıntısına karşı dayanıklı olmasını sağlar. Bu nedenle fayansların ömrünü uzatır.

- İç ve dış köşe profilleri, temizliği kolaylaştırır ve hijyen sağlar. Özellikle banyo ve mutfak gibi nemli alanlarda su sızıntısını önler.

Advantages

- These profiles ensure that the corners are resistant to bumps, scratches and liquid leakage. Therefore, it prolongs the life of the tiles.

- Internal and external corner profiles make cleaning easier and provide hygiene. Prevents water leakage, especially in humid areas such as bathrooms and kitchens.

Kullanım Alanları

- Bu profiller, iç ve dış köşelerde seramik fayansların zarar görmesini önler ve köşeleri korur. Özellikle banyo, mutfak ve duvar fayansları gibi alanlarda yaygın olarak kullanılır.

- İç ve dış köşe profilleri, farklı fayans yüzeylerini düzgünce birleştirir ve estetik bir bitiş sağlar. Bu, fayans dökmesinin daha düzenli ve şık görünmesini sağlar.

Usage Areas

- These profiles prevent the ceramic tiles from being damaged in the inner and outer corners and protect the corners. It is mainly widely used in areas such as bathroom, kitchen and wall tiles.

- Interior and exterior corner profiles neatly combine different tile surfaces and provide an aesthetic finish. This makes the tile flooring look more tidy and stylish.

Profil Türü Profile Type	Paket Adeti Pack Qty
Dış Köşe / Outside Corner	100
İç Köşe / Inner Corner	60



PYPLAST
Ahmet Polat Yapı Markasıdır



Dijital kataloğumuzu QR kodu tarayarak görüntüleyebilirsiniz.
To view our digital catalog, scan the QR code.

Türkey
Discover
the potential

BİZ KİMİZ?

POLAT BANT

, Ambalaj bantları, Endüstriyel Bantlar ve Streç Film üretiminde Türkiye'de ve dünyada her zaman üst kalitede üretim yapmayı ilke edinerek %100 yerli sermaye ile kurulmuş firmadır.

Firmamız tecrübeli kadrosu ve yüksek teknolojiye sahip makine parkuru ile baskılı ve baskız koli bandı, gıda ve palet streç film üretiminde yüksek kapasiteye sahiptir. Sahip olduğu deneyim, yapılan yatırımlar ve AR-GE çalışmaları, müşteri memnuniyetine odaklanan hizmet anlayışı ile müşterilerimizin tüm beklentilerini karşılamaya çalışmaktayız.

Hızlı hizmet, teknoloji ve kaliteyi birleştirme misyonumuz ile çıktığımız bu yolda, güvenilir bir çözüm ortağı olma yolunda ilerleyen firmamız bizi tercih eden tüm müşterilerimize ve bayilerimize sonsuz teşekkürler sunar.

NEDEN POLAT BANT?

Geniş Ebatlama Seçeneği

Müşterilerimizin taleplerine uygun olarak istenilen ebatta ve metrajlarda ürünleri hazırlayabiliyor ve sunabiliyor olmamız, önemli bir hareket alanı ve esneklik sağlamaktadır. Müşterilerimizin beklentilerini karşılayabilecek olan en uygun ürün çeşidini, ürünlerin ebatlarını ve metrajlarını kontrol edebiliyor, ortaya çıkarabiliyor olmamız, sektördeki rakiplerimizden bir adım önde olmamızı ve müşterilerimizin bizi tercih etmelerini sağlamaktadır.

Hizmet Verdiğimiz Sektörler

Piyasada hizmet verdiğimiz, isteklerini karşıladığımız ve yapışkan bantlar, endüstriyel bantlar, yapıştırıcılar konusunda çözümler sunduğumuz sektörler arasında ise Otomotiv, Medikal, Reklamcılık, Matbaa ve Baskı, İnşaat, Plastik Profil, Oluklu Mukavva, Metal, Beyaz Eşya, Kâğıt, Elektrik- Elektronik, Ambalajlama ve Lojistik, Trim ve Profil, Tekstil gibi çok farklı sektörler bulunmaktadır.

Kaliteli Üretim & Sorunsuz Dağıtım

Sahip olduğumuz ileri teknoloji ve eğitim kalitesi yüksek personel gücünü en verimli şekilde kullanarak, müşterilerimizin ihtiyaçlarını en yüksek düzeyde karşılamak için çalışıyoruz. Markamızı kalite kavramı ile özdeşleştirmek için tüm üretim, sevkiyat ve müşteri hizmetleri sürecimizi toplam kalite yönetimi kapsamında yürütüyoruz. Bilimsel ve teknolojik gelişmeleri yakından takip ediyoruz, bu alanda yatırım yapmaktan çekinmiyoruz. Ulaştığımız nokta sayısını artırarak, en hızlı ve en kaliteli sevkiyat modelini geliştirmek için sürekli çalışıyoruz. Müşteri hizmetleri konusunda en iyilerdeniz, taleplere ve müşterilerimizin karşılaştığı sorunlara hızlı çözüm üretiyoruz.





WHO ARE WE?

POLAT BANT was established with 100% domestic capital with the principle of always high quality packing tapes, industrial tapes and stretch film production in Turkey and in the world. Our company has high capacity in the production of printed and non-printed packaging tapes, food and pallet stretch films with its experienced staff and high technology machinery. We try to meet all of our customers' expectations with focus on the customer satisfaction by our experience in the industry, investments and R&D studies.

We set our mission as combining fast service, technology and quality.

Our company, which is on the way to be a reliable solution partner, offers endless thanks to all our customers and dealers who prefer us.

WHY POLAT TAPE?

Wide Size Option

Being able to prepare and offer products in desired sizes and quantities in accordance with the demands of our customers provides an important range of motion and flexibility.

The fact that we can control and reveal the most suitable product range that can meet the expectations of our customers, the dimensions and quantities of the products enables us to be one step ahead of our competitors in the industry and our customers to choose us.

Industries We Serve

The Industries that we serve in the market, meet their demands and offer solutions for adhesive tapes, industrial tapes and stretch films are Automotive, Medical, Advertising, Printing, Construction, Plastic Profile, Corrugated Cardboard, Metal, White Goods, Paper, Electric-Electronic, Packaging and Logistics, Trim and Profile, Textile

High Quality Production & Distribution

We strive to meet the needs of our customers at the highest level by using the most advanced technology and high quality of training personnel power in the most efficient way. We carry out all our production, shipment and customer service processes within the scope of total quality management to identify our brand with the concept of quality

We closely follow scientific and technological developments, we do not hesitate to invest in this field.

We are constantly working to develop the fastest and highest quality shipping model by increasing the number of points we reach. We are the best in customer service, we produce fast solutions to demands and problems that our customers face.

POLAT PLUS

En	Taşıyıcı	Zemin Rengi	Tutkal	Kalınlık
24 mm	BOPP Film	GOLD	Special	38-42 Mikron
36 mm	BOPP Film	GOLD	Special	38-42 Mikron
43 mm	BOPP Film	GOLD	Special	38-42 Mikron
45 mm	BOPP Film	GOLD	Special	38-42 Mikron
60 mm	BOPP Film	GOLD	Special	38-42 Mikron
67 mm	BOPP Film	GOLD	Special	38-42 Mikron

İstenilen metrajda üretim yapılabilmektedir.



POLAT PLUS PAKETLEME BANTLARI

Orta ve yüksek ağırlıktaki kolilerin manuel ve otomatik makinelerde kapatılmasında kullanılır. Firmamıza özel formülle üretilen tutkalın, homojen olarak harmanlanıp OPP film üzerine eşit şekilde sürülmesiyle üretilen bir kolibandı çeşididir. Karton üzerinde etkili bir tutuş gücüne sahiptir.



HOTMELT PAKETLEME BANTLARI

Hafif ve orta ağırlıktaki kolilerin manuel ve otomatik makinelerde kapatılmasında kullanılır. Kauçuk ve reçinenin belirli ısılarda eritilip, homojen olarak harmanlanıp OPP film üzerine eşit şekilde sürülmesiyle üretilen bir kolibandı çeşididir. Kullanılan tutkal, teknik özelliği sayesinde elle koparılabilmek özelliğine sahiptir. Karton üzerinde etkili bir tutuş gücüne sahiptir.



En	Taşıyıcı	Zemin Rengi	Tutkal	Kalınlık
12 mm	BOPP Film	Şeffaf, Beyaz, Taba	Hotmelt	38-45 Mikron
24 mm	BOPP Film	Şeffaf, Beyaz, Taba	Hotmelt	38-45 Mikron
36 mm	BOPP Film	Şeffaf, Beyaz, Taba	Hotmelt	38-45 Mikron
43 mm	BOPP Film	Şeffaf, Beyaz, Taba	Hotmelt	38-45 Mikron
45 mm	BOPP Film	Şeffaf, Beyaz, Taba	Hotmelt	38-45 Mikron
60 mm	BOPP Film	Şeffaf, Beyaz, Taba	Hotmelt	38-45 Mikron
67 mm	BOPP Film	Şeffaf, Beyaz, Taba	Hotmelt	38-45 Mikron

İstenilen metrajda üretim yapılabilmektedir

AKRİLİK PAKETLEME BANTLARI

Akrilik bazlı koli bandı el ile kolay şekilde kopmadığı için bant makinesi ile kullanıma uygundur. Akrilik tutkallı bantlarımız daha çok plastik türevi malzemelerin paketlenmesi için uygundur.



En	Taşıyıcı	Zemin Rengi	Tutkal	Kalınlık
12 mm	BOPP Film	Şeffaf, Beyaz, Taba	Akrilik	38-45 Mikron
24 mm	BOPP Film	Şeffaf, Beyaz, Taba	Akrilik	38-45 Mikron
36 mm	BOPP Film	Şeffaf, Beyaz, Taba	Akrilik	38-45 Mikron
43 mm	BOPP Film	Şeffaf, Beyaz, Taba	Akrilik	38-45 Mikron
45 mm	BOPP Film	Şeffaf, Beyaz, Taba	Akrilik	38-45 Mikron
60 mm	BOPP Film	Şeffaf, Beyaz, Taba	Akrilik	38-45 Mikron
67 mm	BOPP Film	Şeffaf, Beyaz, Taba	Akrilik	38-45 Mikron

İstenilen metrajda üretim yapılabilmektedir

HOTMELT PACKAGING TAPES

It is used for closing light and medium weight boxes in manual and automatic machines. It is a type of packaging tape produced by melting rubber and resin at certain temperatures, blending homogeneously and applying on OPP film. The glue used has the ability to be torn by hand thanks to its technical feature.

It has an effective holding power on cardboard.



Width	Carrier	Ground Color	Glue	Thickness
12 mm	BOPP Film	Transparent, White, Brown	Hotmelt	38-45 Mic.
24 mm	BOPP Film	Transparent, White, Brown	Hotmelt	38-45 Mic.
36 mm	BOPP Film	Transparent, White, Brown	Hotmelt	38-45 Mic.
43 mm	BOPP Film	Transparent, White, Brown	Hotmelt	38-45 Mic.
45 mm	BOPP Film	Transparent, White, Brown	Hotmelt	38-45 Mic.
60 mm	BOPP Film	Transparent, White, Brown	Hotmelt	38-45 Mic.
67 mm	BOPP Film	Transparent, White, Brown	Hotmelt	38-45 Mic.

Production can be done in desired length

ACRYLIC PACKAGING TAPES

Our acrylic glue tapes are mostly suitable for packaging plastic derivative materials.

It is suitable for use with tape machine since acrylic based packaging tape does not break easily by hand.



Width	Carrier	Ground Color	Glue	Thickness
12 mm	BOPP Film	Transparent, White, Brown	Acrylic	38-45 Mic.
24 mm	BOPP Film	Transparent, White, Brown	Acrylic	38-45 Mic.
36 mm	BOPP Film	Transparent, White, Brown	Acrylic	38-45 Mic.
43 mm	BOPP Film	Transparent, White, Brown	Acrylic	38-45 Mic.
45 mm	BOPP Film	Transparent, White, Brown	Acrylic	38-45 Mic.
60 mm	BOPP Film	Transparent, White, Brown	Acrylic	38-45 Mic.
67 mm	BOPP Film	Transparent, White, Brown	Acrylic	38-45 Mic.

Production can be done in desired length



JUMBO MAKİNE TİPİ PAKETLEME BANTLARI

Hafif ve orta ağırlıktaki kolilerin otomatik makinelerde kapatılmasında kullanılır. Kauçuk ve reçinenin belirli ısılarda eritilip, homojen olarak harmanlanıp OPP film üzerine eşit şekilde sürülmesiyle üretilen bir koli çeşididir. Kullanılan tutkal, teknik özelliği sayesinde elle koparılabilmek özelliğine sahiptir. Karton üzerinde etkili bir tutuş gücüne sahiptir.



En	Taşıyıcı	Zemin Rengi	Tutkal	Kalınlık
43 mm	BOPP Film	Şeffaf, Beyaz, Taba	Akrilik/Hotmelt	38-45 Mikron
45 mm	BOPP Film	Şeffaf, Beyaz, Taba	Akrilik/Hotmelt	38-45 Mikron
60 mm	BOPP Film	Şeffaf, Beyaz, Taba	Akrilik/Hotmelt	38-45 Mikron
67 mm	BOPP Film	Şeffaf, Beyaz, Taba	Akrilik/Hotmelt	38-45 Mikron

1000 mt uzunluğa kadar üretim yapılabilmektedir

BASKILI PAKETLEME BANTLARI

Flexo baskı sistemi uygulanarak hotmelt tutkal teknolojisi ile üretilen koli bantlarına baskı yapılmaktadır. 45, 60 ve 67 mm genişliğinde istenilen metrajda baskılı üretim yapılabilmektedir.



En	Taşıyıcı	Zemin Rengi	Tutkal	Kalınlık
45 mm	BOPP Film	İstenilen renk	Hotmelt	38-45 Mikron
60 mm	BOPP Film	İstenilen renk	Hotmelt	38-45 Mikron
67 mm	BOPP Film	İstenilen renk	Hotmelt	38-45 Mikron

İstenilen metrajda üretim yapılabilmektedir



JUMBO MACHINE TYPE PACKING TAPES

It is used for closing light and medium weight boxes by automatic machines. It is a type of packaging tape produced by melting rubber and resin at certain temperatures, blending homogeneously and applying on OPP film. The glue used has the ability to be torn by hand thanks to its technical feature.

It has an effective holding power on cardboard.



Width	Carrier	Ground Color	Glue	Thickness
43 mm	BOPP Film	Transparent, White, Brown	Hotmelt / Acrylic	38-45 Mic.
45 mm	BOPP Film	Transparent, White, Brown	Hotmelt / Acrylic	38-45 Mic.
60 mm	BOPP Film	Transparent, White, Brown	Hotmelt / Acrylic	38-45 Mic.
67 mm	BOPP Film	Transparent, White, Brown	Hotmelt / Acrylic	38-45 Mic.

It can be produced up to 1000 meters in length.

PRINTED PACKAGING TAPES

By applying Flexo printing system, printing is made on the packaging tapes produced with hotmelt glue technology. Printed production can be made in desired lengths of 45, 60 and 67 mm width.



Width	Carrier	Ground Color	Glue	Thickness
45 mm	BOPP Film	Desired Color	Hotmelt	38-45 Mic.
60 mm	BOPP Film	Desired Color	Hotmelt	38-45 Mic.
67 mm	BOPP Film	Desired Color	Hotmelt	38-45 Mic.

Production can be done in desired length

RENKLİ BANTLAR

Renkli bantlarımız BOPP film zeminine Flexo baskı sistemi uygulanarak geniş renk yelpazesinde üretilmektedir. Hafif ve orta ağırlıktaki koliler ve plastik türevi ambalajların kapatılmasında kullanılır.



En	Taşıyıcı	Zemin Rengi	Tutkal	Isl Dayanımı
45 mm	BOPP Film	Geniş Renk Seçeneği	Hotmelt/Akrilik	38-45 Mikron
60 mm	BOPP Film	Geniş Renk Seçeneği	Hotmelt/Akrilik	38-45 Mikron
67 mm	BOPP Film	Geniş Renk Seçeneği	Hotmelt/Akrilik	38-45 Mikron

İstenilen metrajda üretim yapılabilir.

MASKELEME BANTLARI

Makro maskeleme bantları güçlü yapışma özelliği ve uygulama sonrası kolay ve iz bırakmadan sökülmesi sayesinde ideal çözümler sunmaktadır.

Yüksek ısıda iz bırakmaz

Kuvvetli yapışma özelliğine sahiptir

İz bırakmadan kolayca sökülür



Width	Ground Color	Glue	Heat Resistance
24 mm	Cream Color	Natural Rubber	60 C - 80 C
36 mm	Cream Color	Natural Rubber	60 C - 80 C
43 mm	Cream Color	Natural Rubber	60 C - 80 C
45 mm	Cream Color	Natural Rubber	60 C - 80 C
48 mm	Cream Color	Natural Rubber	60 C - 80 C

İstenilen metrajda üretim yapılabilir.



COLORED TAPES

Our colored tapes are produced in a wide range of colors by applying Flexo printing system to the BOPP film ground. It is used for closing light and medium weight boxes and plastic derivative packages.



Width	Carrier	Ground Color	Glue	Thickness
45 mm	BOPP Film	Desired Color	Hotmelt	38-45 Mic.
60 mm	BOPP Film	Desired Color	Hotmelt	38-45 Mic.
67 mm	BOPP Film	Desired Color	Hotmelt	38-45 Mic.

Production can be done in desired length

MASKING TAPES

Makro masking tapes offer ideal solutions thanks to their strong adhesion and easy and no trace removal after application. Does not leave traces at high temperatures.

It has strong adhesion property and easily removed without a trace



Width	Ground Color	Glue	Heat Rezistance
24 mm	Cream Color	Natural Rubber	60 C - 80 C
36 mm	Cream Color	Natural Rubber	60 C - 80 C
43 mm	Cream Color	Natural Rubber	60 C - 80 C
45 mm	Cream Color	Natural Rubber	60 C - 80 C
48 mm	Cream Color	Natural Rubber	60 C - 80 C

Production can be done in desired length

EL TİPİ PALET STREÇ FİLM

50 cm genişliğinde 17 ve 23 mikron kalınlıklarında, istenilen metrajda üretim yapılmaktadır. El tipi streç filmlerimiz %200 gerdirme ve yüksek yapışma özelliğine sahiptir.



Malzeme Cinsi	LLDPE (Lineer Low Density Polietilen)
Baskı Durumu	Baskısız
Çekim Eni	500 mm
Renk	Şeffaf
Kalınlık	17-23 Mikron
Gerdirme	200%
Koli İçi Adet	6

İstenilen metrajda üretim yapılabilmektedir

POWER/SUPER POWER MAKİNE TİPİ PALET STREÇ FİLM

50 cm genişliğinde 17 ve 23 mikron kalınlıklarında, 1500 mt uzunlukta üretim yapılmaktadır. Makine tipi streç filmlerimiz %300 gerdirme ve yüksek yapışma özelliğine sahiptir.



Malzeme Cinsi	LLDPE (Lineer Low Density Polietilen)
Baskı Durumu	Baskısız
Çekim Eni	500 mm
Renk	Şeffaf
Kalınlık	17-23 Mikron
Gerdirme	300%
Koli İçi Adet	1

1500 mt üretim yapılabilmektedir



+90 442 238 08 08

www.ahmetpolat.com.tr | polatyapi.siparis@gmail.com |
Gez Köyü OSB Mahallesi Ek OSB Alanı No: 2 Aziziye/Erzurum

Whatsapp Communication Line : 0506 042 25 25



Türkiye
Discover
the potential